

# Draw the other half

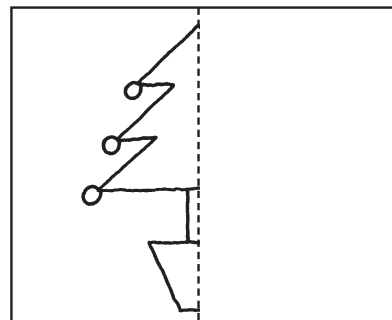

Finish the pictures.

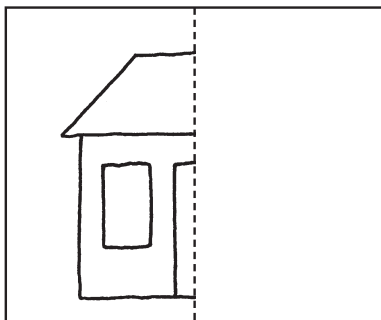
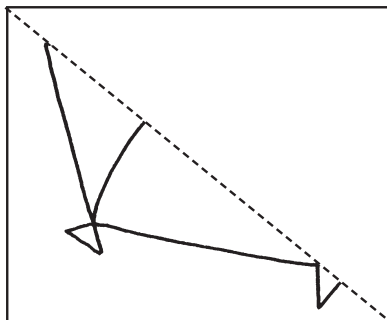
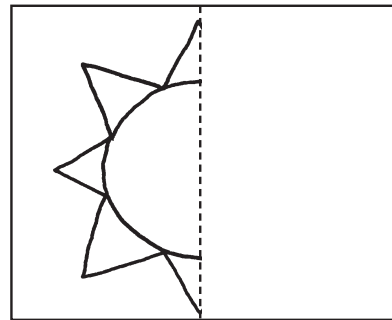
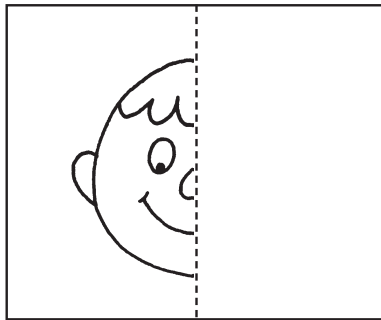
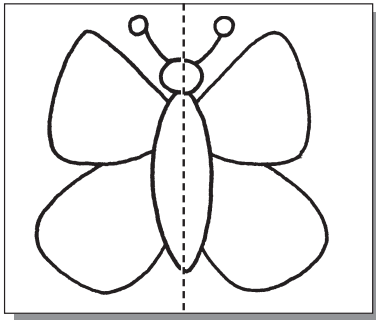

Make the two halves of the pegboards match. Color them in.

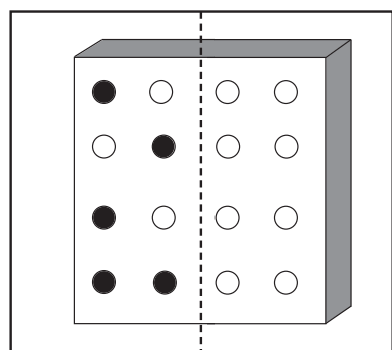
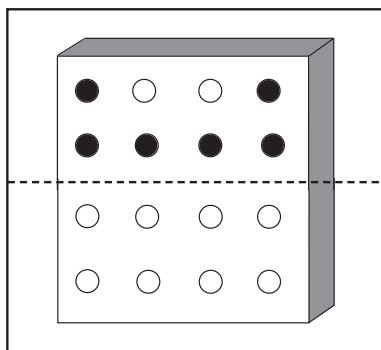
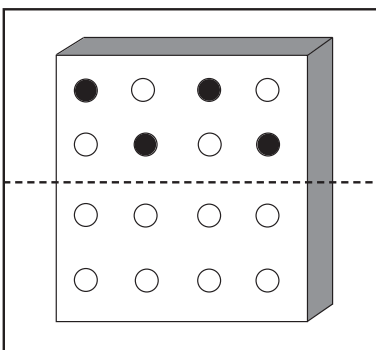
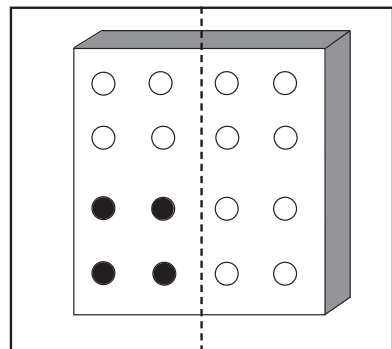
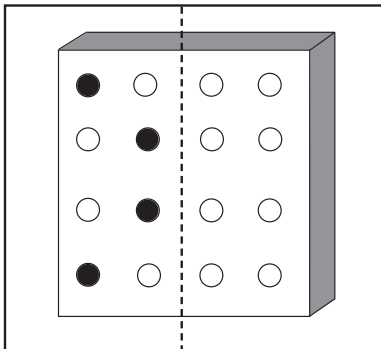
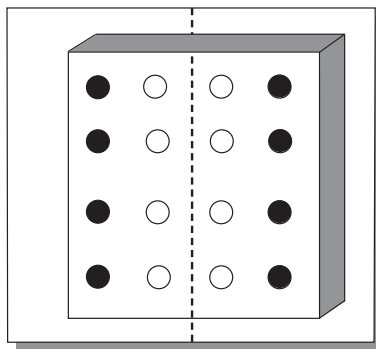

# Draw the other half



Finish the pictures.

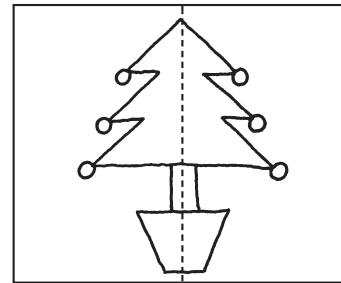
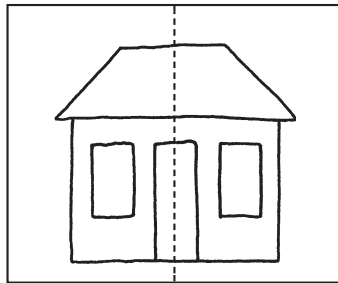
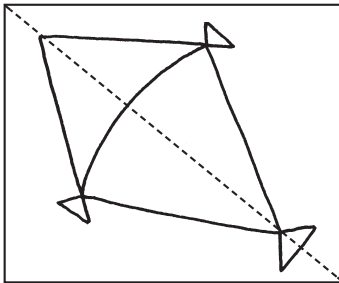
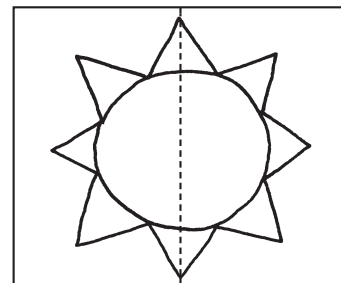
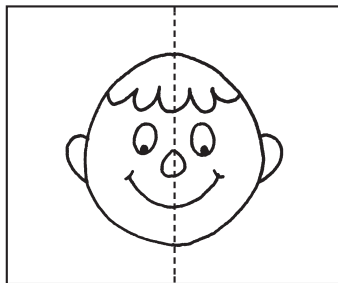
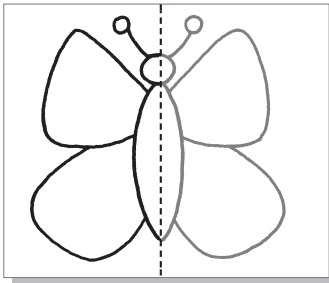

Make the two halves of the pegboards match. Color them in.

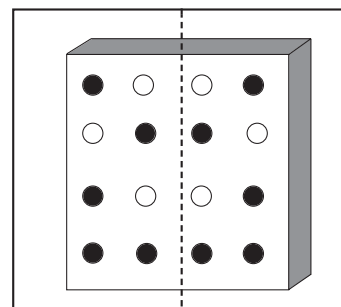
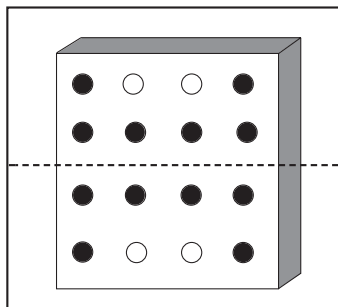
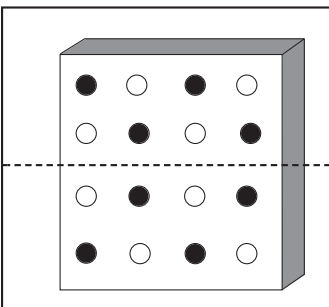
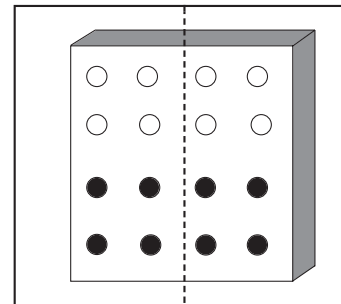
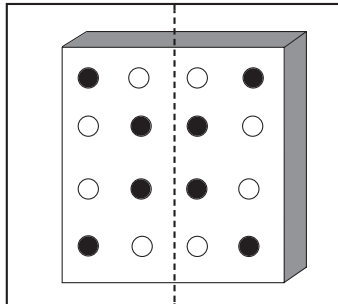
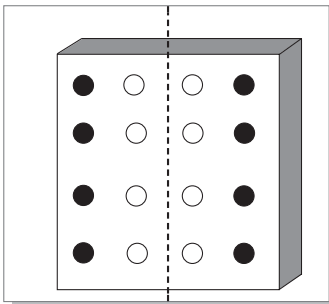

Placing a small mirror along the line of symmetry will enable children to see the complete image. For the second activity, it is important to understand that the unmarked half should be a mirror image of the marked half.